

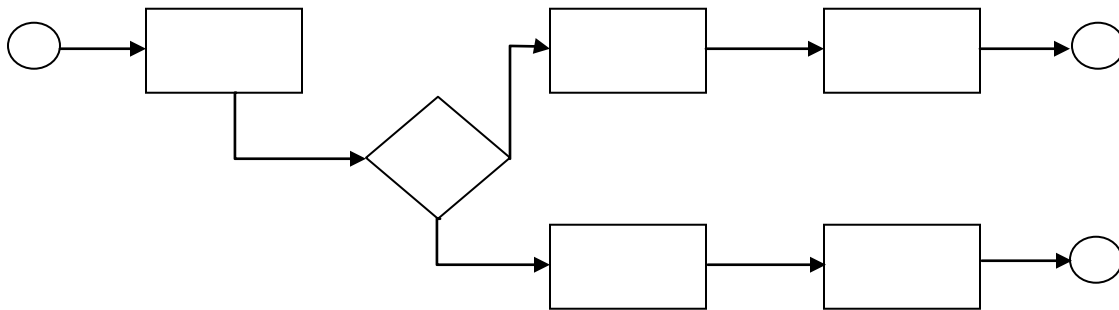





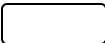

Flow Charts

Flow charts (aka Flow Diagrams) show the relationships between various work elements of a process or project. They show pictures which depict the step-by-step of the process or project. Flow charts create a common language and understanding about the sequence of events, while highlighting shared concerns.

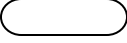

Most frequently used shapes:

Shape	Meaning
	Process
	Alternate process
	Decision
	Data
	Document
	Terminator
	Connector